

Pico60 40dB

Brand- en geluidswerende utiliteitsdeur

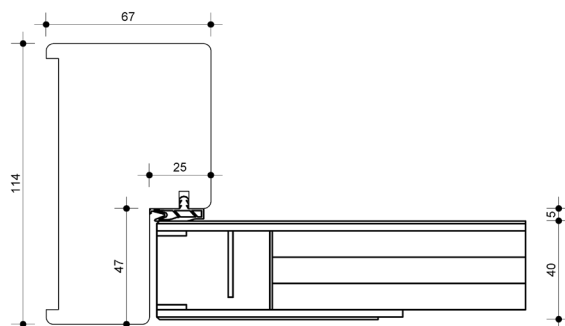

Standaard:

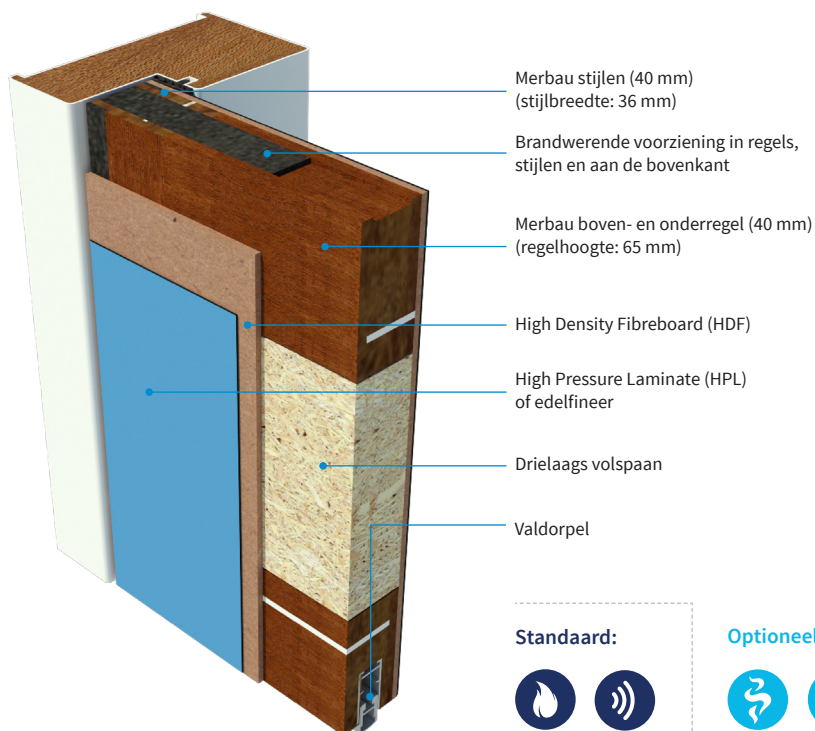

Optioneel:



Enkele deur

Deurbladdikte	HPL: 40 mm Machinaal geplamuurd: 38 mm
Maximale hoogte	2673 mm
Maximale breedte	1231 mm
Maximale oppervlak	2,99 m ²
Maximale ruimte onder de deur	6 mm
Bovenpaneel	-
Vuurzijde	Draaiend naar het vuur toe en van het vuur af
Aanslagspanning kozijn	Houten kozijn: VM 550 kg/m ³ - 25 mm Stalen kozijn: 20 mm - gipsgevuld
Aanslagrubber kozijn	Brandvertragende uitvoering
Uitvoering	Stomp
Kantafwerking	Onbehandeld, gelakt, geschilderd, kunststof ABS 2 mm
Deurnaald	-
Brandwerend	60 minuten; EW60
Rookwerend	Nee
Geluidwerend	Rw 40 dB, Rw'p 37 dB; voorwaarde valdorpel en 3-zijdig kaderprofiel in kozijn
In- en uitbraakwerend	Nee
Vochtwerend *	Nee (ja, incl. Triplex i.p.v. HDF en onderkant ecosealen)
Klimaatklasse	Nee
MVO	Optioneel FSC
GND	Optioneel GND label
Glasopening	Max. 951 x 2133 mm - Stijlbreedte min. 140 mm / borstwing min. 335 mm
Hang- en sluitwerk	Optioneel
Kozijnstype	Hout / staal

* Definitie vochtwerend

Vochtwerend, maar niet waterbestendig

-  Standaard
-  Brandwerend
-  Rookwerend Sa + S200
-  Rookwerend Sa
-  Rookwerend S200
-  Geluidwerend
-  In- en uitbraakwerend
-  Vochtwerend
-  Klimaatklasse
-  Klimaatklasse A
-  Klimaatklasse B
-  Klimaatklasse C
-  Watervast
-  Stralingswerend
-  Kogelwerend
-  Deurstel
-  Bovenpaneel
-  MVO / GND
-  Compleet element

