

Pico60 40dB

Brand- en geluidswerende utiliteitsdeur

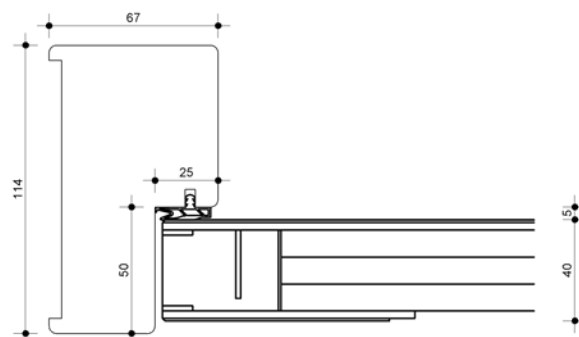

Standaard:

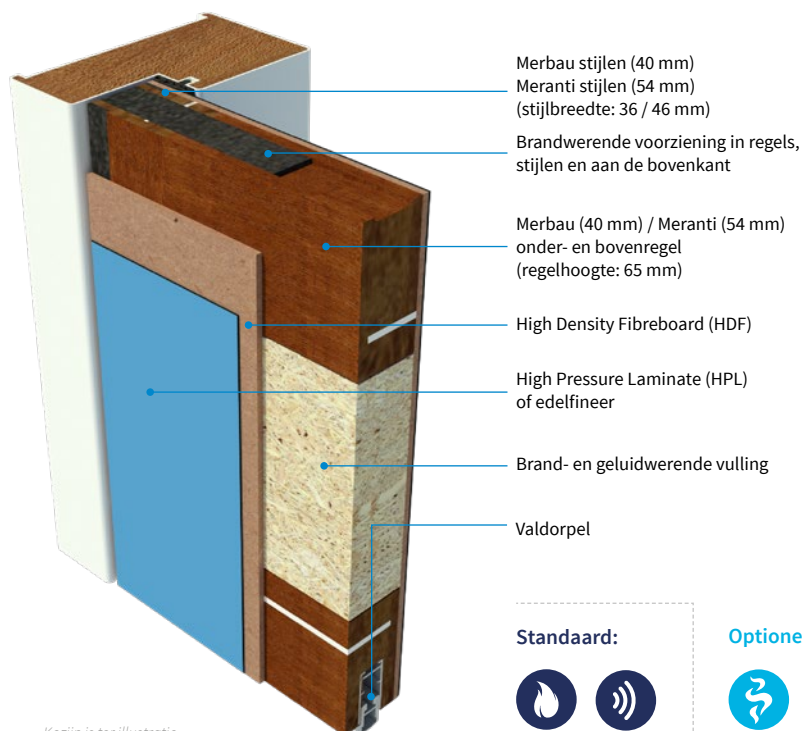









Optioneel:



Kozijn is ter illustratie

Enkele deur

Deurbladdikte	HPL: 40 mm / 54 mm Machinaal geplamuurd: 38 mm / 54 mm
Gewicht	Ca. 28 kg/m ² (40 mm deur) / 37 kg/m ² (54 mm deur)
Maximale hoogte	2674 mm
Maximale breedte	1231 mm
Maximale oppervlak	2,99 m ²
Maximale ruimte onder de deur	6 mm
Bovenpaneel	N.v.t.
Vuurzijde	Draaiend naar het vuur toe en van het vuur af
Aanslagsponning kozijn	Houten kozijn: VM 550 kg/m ³ - 25 mm Stalen kozijn: 20 mm - gipsgevuld
Aanslagrubber kozijn	Brandvertragende uitvoering
Uitvoering	Stomp / Indek (geldt alleen voor de 54 mm uitvoering)
Kantafwerking	Onbehandeld, gelakt, geschilderd, kunststof ABS 2 mm (niet mogelijk bij indek uitvoering)
Deurnaald	N.v.t.
Brandwerend	60 minuten; EW60
Rookwerend	Optioneel Sa / S200
Geluidwerend	Rw 40 dB, Rw'p 37dB
In- en uitbraakwerend	Optioneel RC2 / RC3
Klimaatklasse	Optioneel klimaat A / B / C
MVO	Optioneel FSC
GND	Optioneel GND label
Glasopening	955 mm x 2133 mm - Stijlbreedte min. 140 mm / borstwering min. 335 mm
Hang- en sluitwerk	Optioneel
Kozijn type	Hout / Staal

-  Standaard
-  Brandwerend
-  Rookwerend Sa + S200
-  Rookwerend Sa
-  Rookwerend S200
-  Geluidwerend
-  In- en uitbraakwerend
-  Klimaatklasse
-  Klimaatklasse A
-  Klimaatklasse B
-  Klimaatklasse C
-  Watervast
-  Stralingswerend
-  Kogelwerend
-  Deurstel
-  Bovenpaneel
-  MVO / GND
-  Compleet element

