

# PicoBulletproof

Kogelwerende utiliteitsdeur

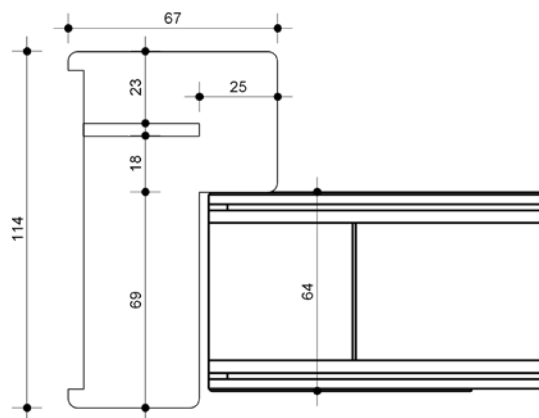
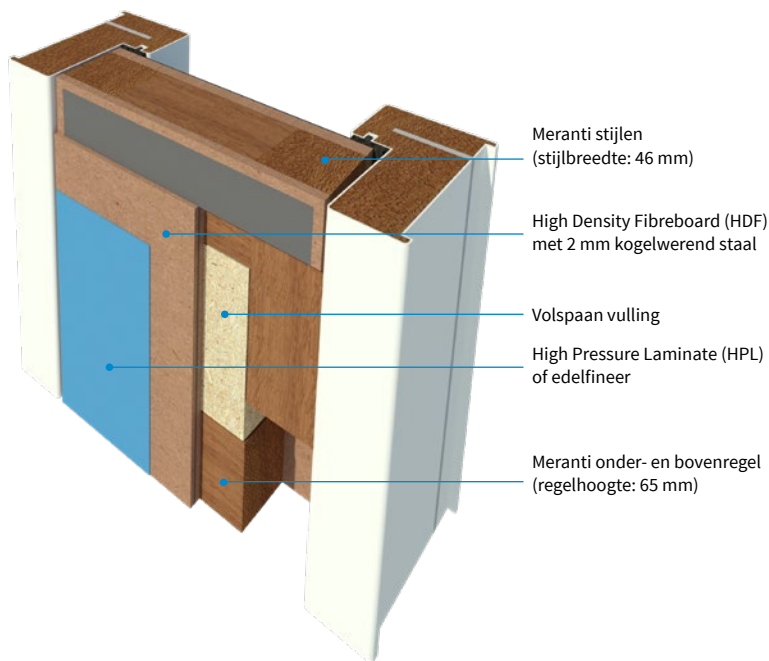

Kozijn is ter illustratie

Standaard:













Optioneel:



## Enkele deur

Deurbladdikte	HPL: 64 mm Machinaal geplamuurd: 64 mm
Gewicht	65 kg/m <sup>2</sup>
Maximale hoogte	2980 mm
Maximale breedte	1280 mm
Maximale oppervlak	N.v.t.
Maximale ruimte onder de deur	5 mm
Bovenpaneel	N.v.t.
Aanslagspanning kozijn	25 mm
Aanslagrubber kozijn	Toegestaan
Uitvoering	Stomp
Kantafwerking	Onbehandeld, glakt, geschilderd
Kogelwerend	FB3 S
Brandwerend	N.v.t.
Rookwerend	Optioneel Sa-S200
Geluidwerend	N.v.t.
In- en uitbraakwerend	Optioneel RC2 / RC3
Klimaatklasse	Nee
MVO	Optioneel FSC
GND	Optioneel GND label
Glasopening	N.v.t.
Hang- en sluitwerk	Slot Brondool 4200
Kozijn type	Hout (> 550 kg/m <sup>3</sup> ) met staal inleg / Staal (mortel gevuld)

-  Standaard
-  Brandwerend
-  Rookwerend Sa + S200
-  Rookwerend Sa
-  Rookwerend S200
-  Geluidwerend
-  In- en uitbraakwerend
-  Klimaatklasse
-  Klimaatklasse A
-  Klimaatklasse B
-  Klimaatklasse C
-  Watervast
-  Stralingswerend
-  Kogelwerend
-  Deurstel
-  Bovenpaneel
-  MVO / GND
-  Compleet element

