

PicoSpec RC2

In- en uitbraakwerende utiliteitsdeur

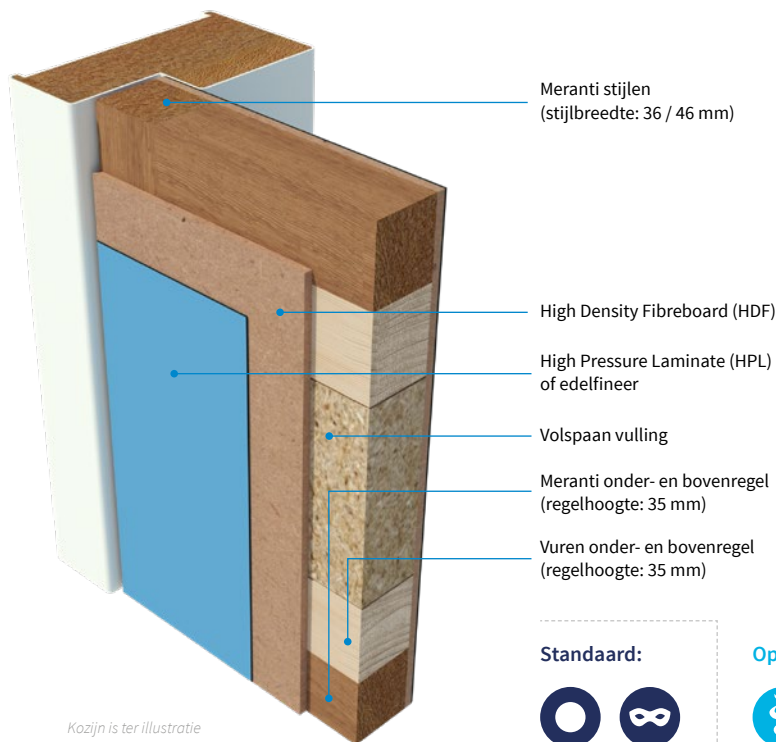

Kozijn is ter illustratie

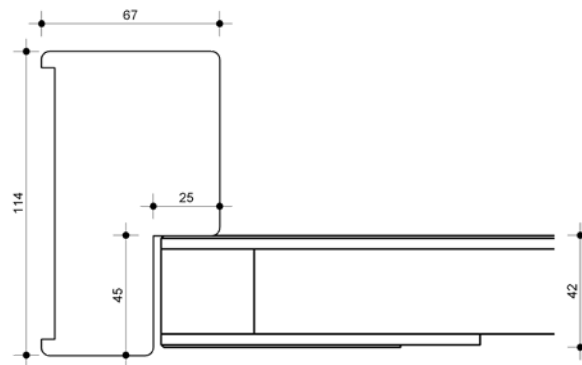

Standaard:











Optioneel:



Enkele deur

Dubbele deur

Deurbladdikte	HPL: 42 mm / 54 mm Machinaal geplamuurd: 42 mm / 54 mm	HPL: 42 mm / 54 mm Machinaal geplamuurd: 42 mm / 54 mm
Gewicht	Ca. 21 kg/m ² (40 mm deur) / 26 kg/m ² (54 mm deur)	Ca. 21 kg/m ² (40 mm deur) / 26 kg/m ² (54 mm deur)
Maximale hoogte	2778 mm	2400 mm
Maximale breedte	1116 mm	952 mm
Maximale oppervlak	N.v.t.	N.v.t.
Maximale ruimte onder de deur	N.v.t.	N.v.t.
Bovenpaneel	N.v.t.	N.v.t.
Vuurzijde	N.v.t.	N.v.t.
Aanslagspanning kozijn	25 mm	25 mm
Aanslagrubber kozijn	Toegestaan	Toegestaan
Uitvoering	Stomp / Indek	Stomp / Indek
Kantafwerking	Onbehandeld, gelakt, geschilderd, kunststof (niet bij opdek) ABS (2 mm)	Onbehandeld, gelakt, geschilderd, kunststof (niet bij opdek) ABS (2 mm)
Deurnaald	N.v.t.	Aluminium deurnaald
Brandwerend	Nee	Nee
Rookwerend	Optioneel Sa / S200	Optioneel Sa / S200
Geluidwerend	Optioneel 35-42dB	Optioneel 35-41dB
In- en uitbraakwerend	RC2	RC2
Klimaatklasse	Optioneel klimaat A / B / C	Optioneel klimaat A / B / C
MVO	Optioneel FSC	Optioneel FSC
GND	Optioneel GND label	Optioneel GND label
Glasopening	636 mm x 1998 mm, borstwering min. 350 mm - P5A glas	530 mm x 1665 mm, borstwering min. 350 mm - P5A glas
Hang- en sluitwerk	Optioneel	Optioneel
Kozijn type	Hout (> 550kg/m ³) / staal (ongevuld)	Hout (> 550kg/m ³) / staal (ongevuld)

-  Standaard
-  Brandwerend
-  Rookwerend Sa + S200
-  Rookwerend Sa
-  Rookwerend S200
-  Geluidwerend
-  In- en uitbraakwerend
-  Klimaatklasse
-  Klimaatklasse A
-  Klimaatklasse B
-  Klimaatklasse C
-  Watervast
-  Stralingswerend
-  Kogelwerend
-  Deurstel
-  Bovenpaneel
-  MVO / GND
-  Compleet element

