

# Pico60

Brandwerende utiliteitsdeur

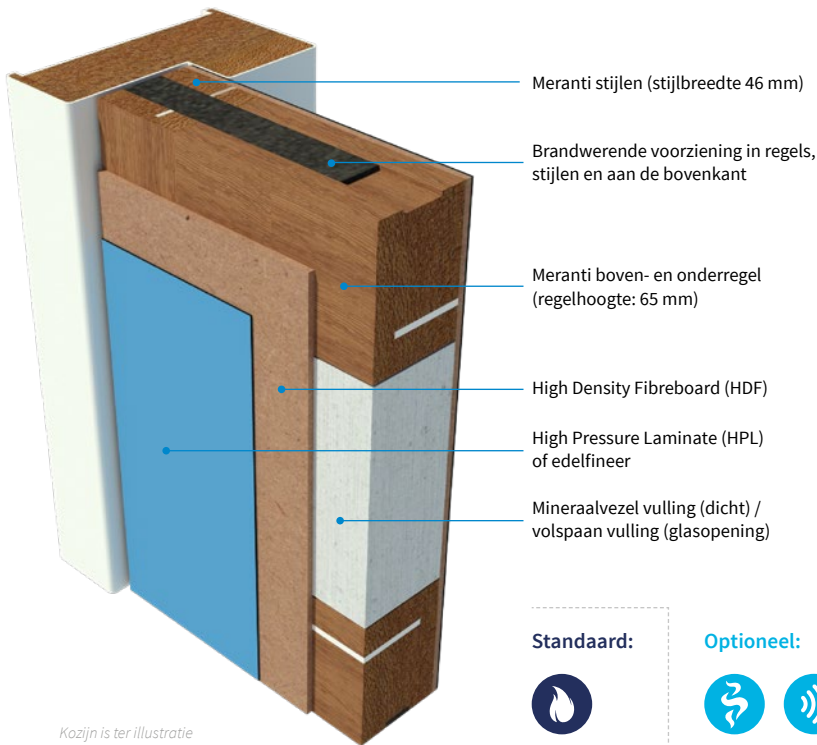

Kozijn is ter illustratie

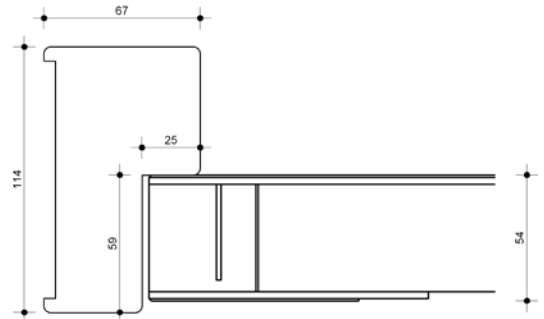

Standaard:















Optioneel:



## Enkele deur

## Dubbele deur

Deurbladdikte	HPL: 54 mm Machinaal geplamuurd: 54 mm	HPL: 54 mm Machinaal geplamuurd: 54 mm
Gewicht	Ca. 37 kg/m <sup>2</sup>	Ca. 37 kg/m <sup>2</sup>
Maximale hoogte	2674 mm	2315 mm
Maximale breedte	1231 mm	1227 mm
Maximale oppervlak	2,99 m <sup>2</sup>	N.v.t.
Maximale ruimte onder de deur	6 mm	6 mm
Bovenpaneel	Toegestaan, zie productblad bovenpaneel	Toegestaan, zie productblad bovenpaneel
Vuurzijde	Draaiend naar het vuur toe en van het vuur af	Draaiend naar het vuur toe en van het vuur af
Aanslagsponning kozijn	Houten kozijn: VM 550 kg/m <sup>3</sup> - 25 mm Stalen kozijn: 20 mm - gipsgevuuld	Houten kozijn: VM 550 kg/m <sup>3</sup> - 25 mm Stalen kozijn: 20 mm - gipsgevuuld
Aanslagrubber kozijn	Brandvertragende uitvoering	Brandvertragende uitvoering
Uitvoering	Stomp / Indek (geldt alleen voor de 54 mm uitvoering)	Stomp / Indek
Kantafwerking	Onbehandeld, gelakt, geschilderd, kunststof ABS 2 mm (niet mogelijk bij indek uitvoering)	Onbehandeld, gelakt, geschilderd, kunststof ABS 2 mm (niet mogelijk bij indek uitvoering)
Deurnaald	N.v.t.	Aluminium brandwerende deurnaald
Brandwerend	60 minuten; EW60 / EI1 60	60 minuten; EW60
Rookwerend	Optioneel Sa / S200	Optioneel Sa / S200
Geluidwerend	Optioneel 35 - 41dB	Optioneel 35 - 41dB
In- en uitbraakwerend	Optioneel RC2 / RC3	Optioneel RC2 / RC3
Klimaatklasse	Optioneel klimaat A / B / C	Optioneel klimaat A / B / C
MVO	Optioneel FSC	Optioneel FSC
GND	Optioneel GND label	Optioneel GND label
Glasopening	955 mm x 2133 mm - Stijlbreedte min. 140 mm / borstwering min. 335 mm	830 mm x 1840 mm - Stijlbreedte min. 140 mm / borstwering min. 335 mm
Hang- en sluitwerk	Optioneel	Optioneel
Kozijnstype	Hout / Staal	Hout / Staal

-  Standaard
-  Brandwerend
-  Rookwerend Sa + S200
-  Rookwerend Sa
-  Rookwerend S200
-  Geluidwerend
-  In- en uitbraakwerend
-  Klimaatklasse
-  Klimaatklasse A
-  Klimaatklasse B
-  Klimaatklasse C
-  Watervast
-  Stralingswerend
-  Kogelwerend
-  Deurstel
-  Bovenpaneel
-  MVO / GND
-  Compleet element

