

Pico90 ClimateA

Brandwerende klimaatklasse utiliteitsdeur

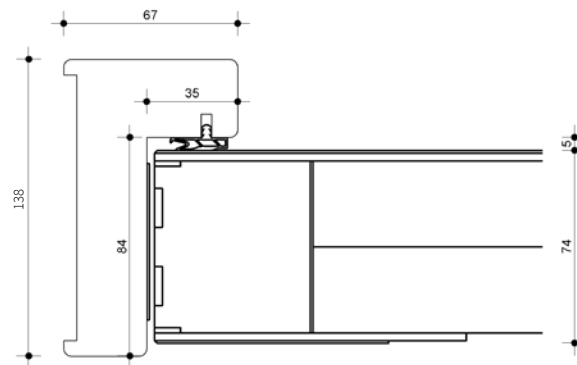

Standaard:

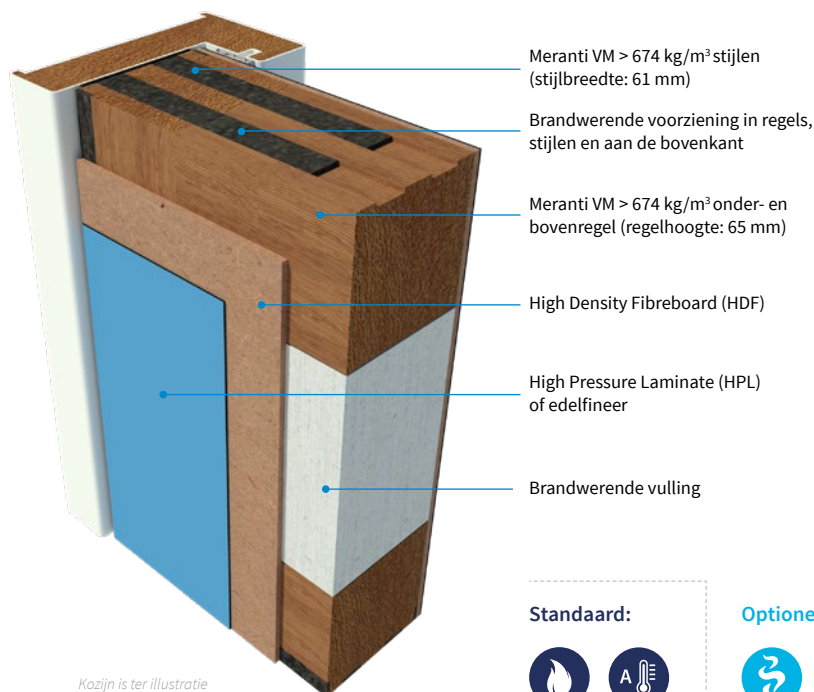

Optioneel:



Enkele deur

Deurbladdikte HPL: 74 mm
Machinaal geplamuurd: 74 mm

Gewicht Ca. 28 kg/m²

Maximale hoogte 2358 mm

Maximale breedte 1080 mm

Maximale oppervlak 2,55 m²

Maximale ruimte onder de deur 6 mm

Bovenpaneel N.v.t.

Vuurzijde Draaiend naar het vuur toe en van het vuur af

Aanslagsponning kozijn Houten kozijn: VM 800 kg/m³ - 35 mm
Stalen kozijn: 25 mm - gips/mortelgevuld

Aanslagrubber kozijn Brandvertragende uitvoering

Uitvoering Stomp

Kantafwerking Onbehandeld, gelakt, geschilderd

Brandwerend 90 minuten; EW90

Rookwerend Optioneel Sa / S200

Geluidwerend N.v.t.

In- en uitbraakwerend Optioneel RC2

Klimaatklasse A (23 grC-30% RV ⇔ 18 grC-50% RV)

Krommingsklasse 2









MVO Optioneel FSC

GND Optioneel GND label

Glasopening N.v.t.

Hang- en sluitwerk Optioneel

Kozijnstype Hout / Staal

-  Standaard
-  Brandwerend
-  Rookwerend Sa + S200
-  Rookwerend Sa
-  Rookwerend S200
-  Geluidwerend
-  In- en uitbraakwerend
-  Klimaatklasse
-  Klimaatklasse A
-  Klimaatklasse B
-  Klimaatklasse C
-  Watervast
-  Stralingswerend
-  Kogelwerend
-  Deurstel
-  Bovenpaneel
-  MVO / GND
-  Compleet element

