

# Pico30 ClimateA

Brandwerende klimaatklasse utiliteitsdeur

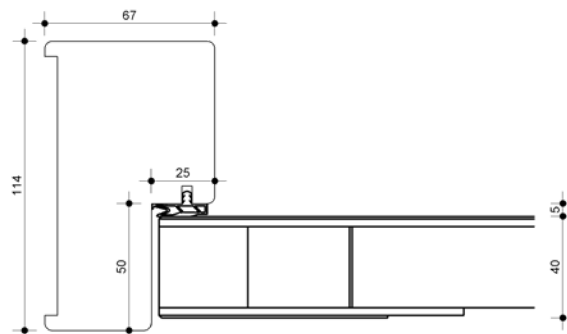

**Standaard:**

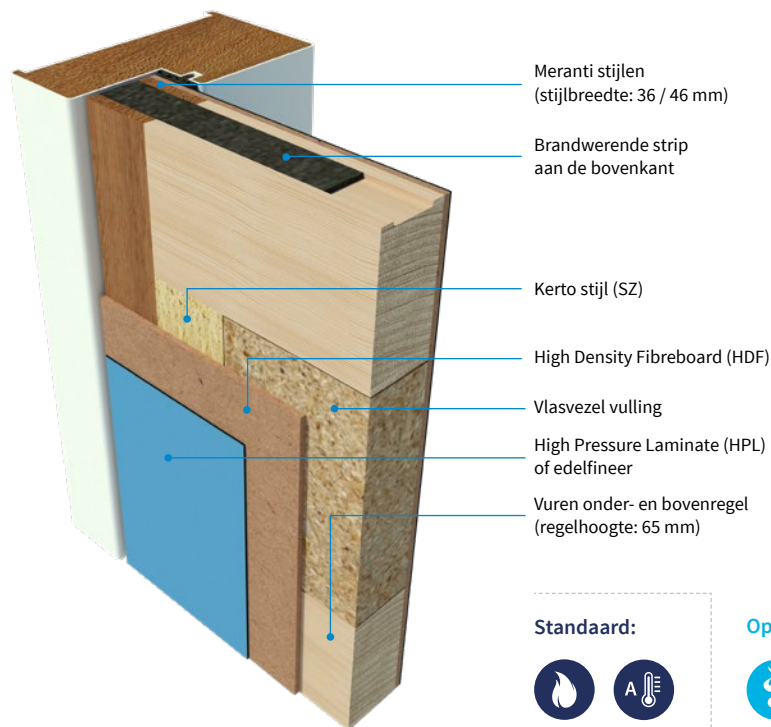

**Optioneel:**



Kozijn is ter illustratie

## Enkele deur

Deurbladdikte

HPL: 40 mm / 54 mm  
Machinaal geplamuurd: 38 mm / 54 mm

Gewicht

Ca. 21 kg/m<sup>2</sup> (40 mm deur) / 26 kg/m<sup>2</sup> (54 mm deur)

Maximale hoogte

2400 mm

Maximale breedte

980 mm

Maximale oppervlak

N.v.t.

Maximale ruimte onder de deur

6 mm

Bovenpaneel

N.v.t.

Vuurzijde

Draaiend naar het vuur toe en van het vuur af

Aanslagsponning kozijn

Houten kozijn: VM 450 kg/m<sup>3</sup> - 25 mm  
Stalen kozijn: 20 mm - kozijn ongevuld - flexpan 15x1 in kozijnstijl

Aanslagrubber kozijn

Brandvertragende uitvoering

Uitvoering

Stomp / Indek (geldt alleen voor de 54 mm uitvoering)

Kantafwerking

Onbehandeld, gelakt, geschilderd, kunststof ABS 2 mm (niet mogelijk bij indek uitvoering)

Brandwerend

30 minuten; EW30 / EI1 30

Rookwerend

Optioneel Sa / S200

Geluidwerend

Optioneel 35 - 42dB

In- en uitbraakwerend

Optioneel RC2 / RC3

Klimaatklasse

A (23 grC-30% RV ↔ 18 grC-50% RV)

Krommingsklasse

2

MVO

Optioneel FSC

GND

Optioneel GND label

Glasopening











1092 mm x 2133 mm (oppervlakte < 2,11 m<sup>2</sup>) - Stijlbreedte min. 140 mm / borstwering min. 200 mm

Hang- en sluitwerk

Optioneel

Kozijnstype

Hout / Staal

-  Standaard
-  Brandwerend
-  Rookwerend Sa + S200
-  Rookwerend Sa
-  Rookwerend S200
-  Geluidwerend
-  In- en uitbraakwerend
-  Klimaatklasse
-  Klimaatklasse A
-  Klimaatklasse B
-  Klimaatklasse C
-  Watervast
-  Stralingswerend
-  Kogelwerend
-  Deurstel
-  Bovenpaneel
-  MVO / GND
-  Compleet element

