

Pico30 Rw 42dB

Brand- en geluidswerende utiliteitsdeur (Rw'p 39dB)

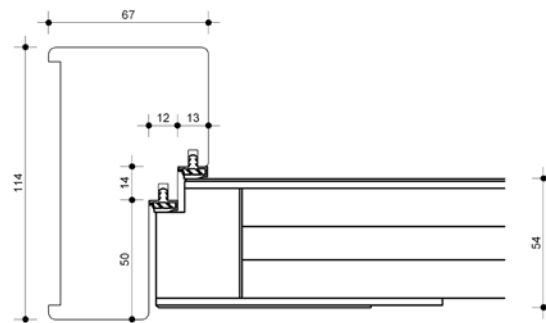
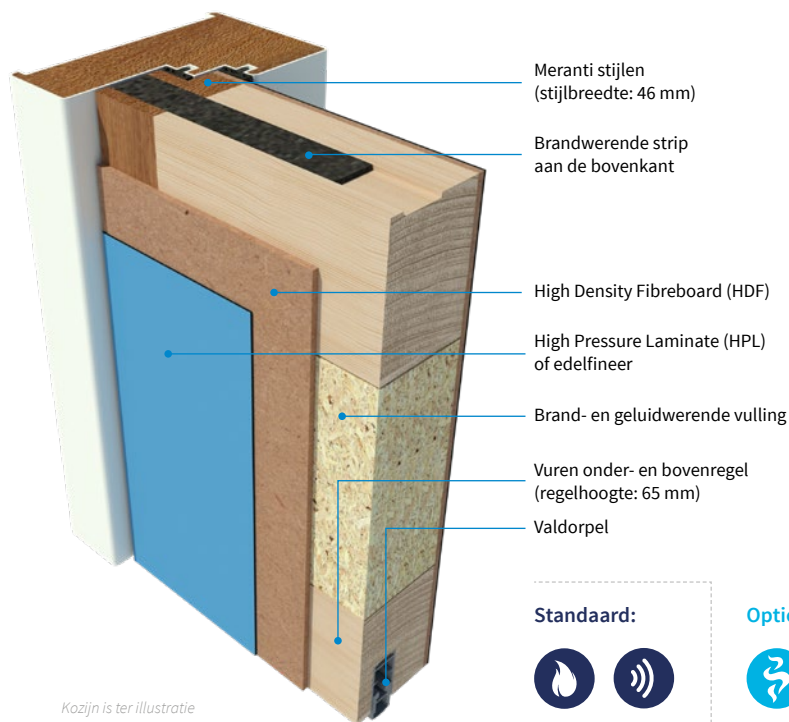

Kozijn is ter illustratie

Standaard:











Optioneel:



Enkele deur

Deurbladdikte	HPL: 54 mm Machinaal geplamuurd: 54 mm
Gewicht	Ca. 33 kg/m ² (54 mm deur)
Maximale hoogte	2825 mm
Maximale breedte	1472 mm
Maximale oppervlak	3,86 m ²
Maximale ruimte onder de deur	6 mm
Bovenpaneel	N.v.t.
Vuurzijde	Draaiend naar het vuur toe en van het vuur af
Aanslagsponning kozijn	Houten kozijn: VM 450 kg/m ³ - 12/13 mm Stalen kozijn: 20/20 mm - kozijn onge vuld - flexpan 15x1 in kozijnstijl
Aanslagrubber kozijn	Brandvertragende uitvoering
Uitvoering	Indek
Kantafwerking	Onbehandeld, gelakt, geschilderd
Deurnaald	N.v.t.
Brandwerend	30 minuten; EW30 / EI1 30
Rookwerend	Optioneel Sa / S200
Geluidwerend	Rw 42dB, Rw'p 39dB
In- en uitbraakwerend	Optioneel RC2 / RC3
Klimaatklasse	Optioneel klimaat A / B / C
MVO	Optioneel FSC
GND	Optioneel GND label
Glasopening	1092 mm x 2133 mm (oppervlakte < 2,11 m ²) Stijlbreedte min. 140 mm / borstwering min. 200 mm
Hang- en sluitwerk	Optioneel
Kozijn type	Hout / Staal

-  Standaard
-  Brandwerend
-  Rookwerend Sa + S200
-  Rookwerend Sa
-  Rookwerend S200
-  Geluidwerend
-  In- en uitbraakwerend
-  Klimaatklasse
-  Klimaatklasse A
-  Klimaatklasse B
-  Klimaatklasse C
-  Watervast
-  Stralingswerend
-  Kogelwerend
-  Deurstel
-  Bovenpaneel
-  MVO / GND
-  Compleet element

