

PicoSound Rw,p 36dB

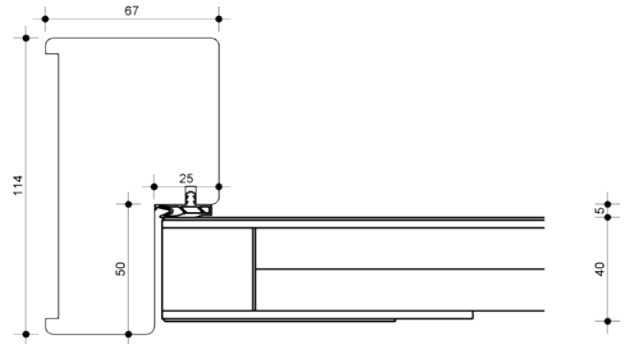

Geluidswerende utiliteitsdeur (Rw 38dB)

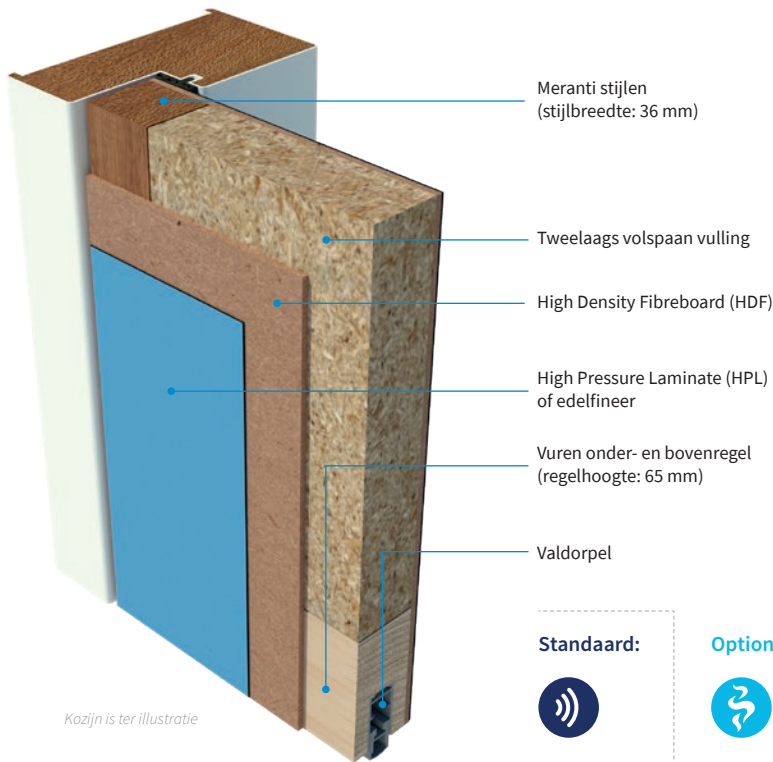

Kozijn is ter illustratie

Standaard:



Optioneel:



Enkele deur

Dubbele deur

Deurbladdikte	HPL: 40 mm Machinaal geplamuurd: 38 mm	HPL: 40 mm / 54 mm Machinaal geplamuurd: 38 mm / 54 mm
Gewicht	Ca. 26 kg/m ²	Ca. 26 kg/m ² (40 mm deur) / 33 kg/m ² (54 mm deur)
Maximale hoogte	2980 mm	2980 mm
Maximale breedte	1280 mm	1280 mm
Maximale oppervlak	N.v.t.	N.v.t.
Maximale ruimte onder de deur	N.v.t.	N.v.t.
Bovenpaneel	Optioneel	N.v.t.
Vuurzijde	N.v.t.	N.v.t.
Aanslagsponning kozijn	≥ 15 mm	≥ 15 mm
Aanslagrubber kozijn	Ja	Ja
Uitvoering	Stomp / Indek	Stomp
Kantafwerking	Onbehandeld, gelakt, geschilderd, kunststof ABS (2 mm)	Onbehandeld, gelakt, geschilderd, kunststof ABS (2 mm)
Brandwerend	Nee	Nee
Brandvoortplanting	Optioneel brandklasse B, S1-d0	Optioneel brandklasse B, S1-d0
Rookwerend	Optioneel Sa / S200	Optioneel Sa / S200
Geluidwerend	Rw,p 36dB, Rw 38dB	Rw,p 38dB, Rw 41dB
In- en uitbraakwerend	Optioneel RC2	Optioneel RC2
Klimaatklasse	Optioneel klimaat A / B / C	Optioneel klimaat A / B / C
MVO	Optioneel FSC®	Optioneel FSC®
GND	Optioneel GND label	Optioneel GND label
Glasopening	Stijlbreedte 140 mm / borstwering 200 mm	Stijlbreedte 140 mm / Borstwering 200 mm
Hang- en sluitwerk	Optioneel	Optioneel
Kozijntype	Hout / Staal	Hout / Staal

-  Standaard
-  Brandwerend
-  Rookwerend Sa + S200
-  Rookwerend Sa
-  Rookwerend S200
-  Geluidwerend
-  In- en uitbraakwerend
-  Klimaatklasse
-  Klimaatklasse A
-  Klimaatklasse B
-  Klimaatklasse C
-  Watervast
-  Stralingswerend
-  Kogelwerend
-  Deurstel
-  Bovenpaneel
-  MVO / GND
-  Compleet element

