

PicoResidence ClimateC

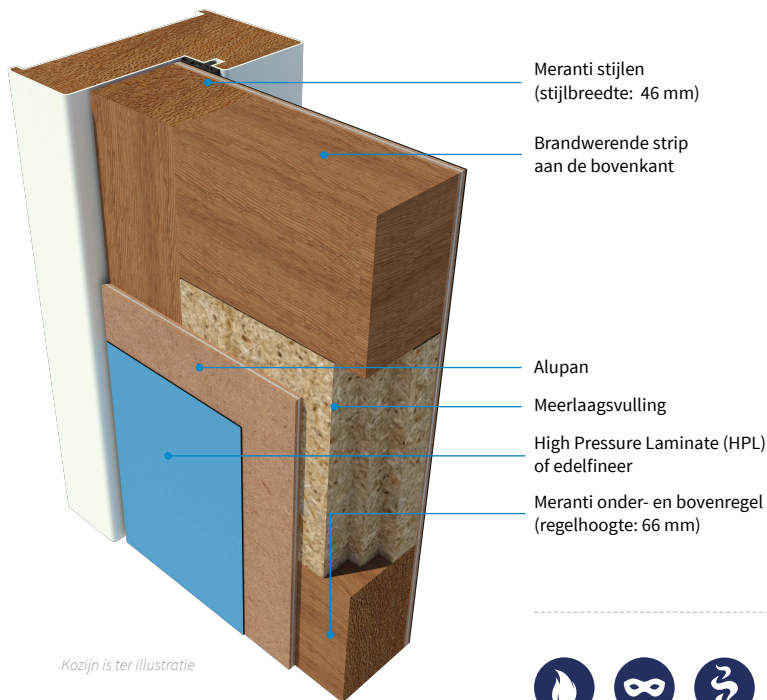

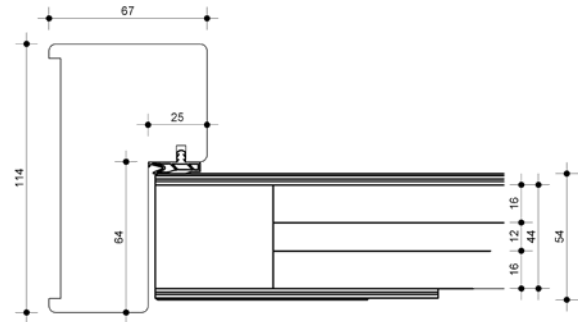











Kozijn is ter illustratie



Enkele deur

Deurbladdikte	HPL: 54 mm Machinaal geplamuurd: 54 mm
Gewicht	26 kg/m ²
Maximale hoogte	2778 mm
Maximale breedte	1116 mm
Maximale oppervlak	N.v.t.
Maximale ruimte onder de deur	6 mm
Bovenpaneel	N.v.t.
Vuurzijde	Draaiend naar het vuur toe en van het vuur af
Aanslagspanning kozijn	Houten kozijn: VM 550 kg/m ³ - 25 mm Stalen kozijn: 20 mm - kozijn ongevuuld - flexpan 15x1 in kozijnstijl
Aanslagrubber kozijn	Brandvertragende uitvoering
Uitvoering	Stomp
Kantafwerking	Onbehandeld, gelakt, geschilderd, kunststof ABS 2 mm (niet mogelijk bij indek uitvoering)
Brandwerend	30 minuten; EW30 / EI1 30
Rookwerend	Sa / S200
Geluidwerend	Rw'p 42dB, Rw 44dB
In- en uitbraakwerend	RC2
Klimaatklasse	C (23 grC-30% RV ↔ 3 grC-85% RV)
Thermische isolatie	U=1,2
MVO	Optioneel FSC®
GND	Optioneel GND label
Glasopening (BxH)	245x1245 mm, borstwering min. 350 mm - P4A glas
Hang- en sluitwerk	Optioneel beslag of cilinder met kerntrekbeveiliging
Kozijnstype	Hout / Staal

-  Standaard
-  Brandwerend
-  Rookwerend Sa + S200
-  Rookwerend Sa
-  Rookwerend S200
-  Geluidwerend
-  In- en uitbraakwerend
-  Klimaatklasse
-  Klimaatklasse A
-  Klimaatklasse B
-  Klimaatklasse C
-  Thermische isolatie
-  Watervast
-  Stralingswerend
-  Kogelwerend
-  Deurstel
-  Bovenpaneel
-  MVO / GND
-  Compleet element



Van Vuuren Grou B.V.
J.W. de Visserwei 5
9001 ZE Grou

+31 (0)566 62 37 37
www.vanvuuren.nl
sales@vanvuuren.nl

Van Vuuren. Voor deurconcepten.