

PicoAqua

Waterwerende en watervaste utiliteitsdeur

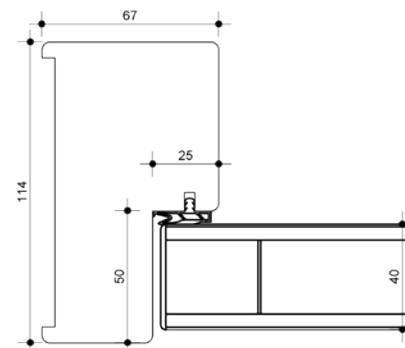
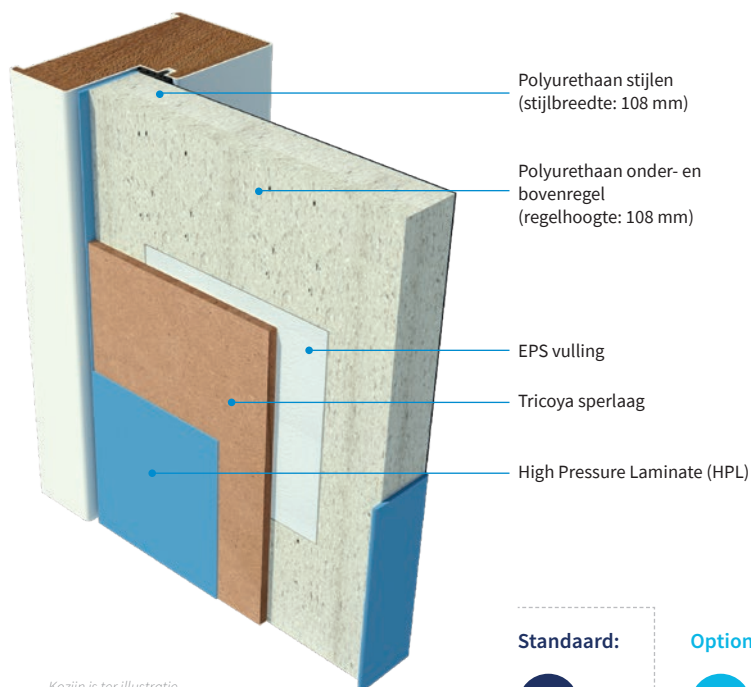

Kozijn is ter illustratie

Standaard:











Optioneel:



Enkele deur

Dubbele deur

Deurbladdikte	HPL: 40 mm	HPL: 40 mm
Gewicht	Ca. 16 kg/m ² (40 mm)	Ca. 16 kg/m ² (40 mm)
Maximale hoogte	2380 mm	2380 mm
Maximale breedte	1220 mm	1220 mm
Maximale oppervlak	N.v.t.	N.v.t.
Maximale ruimte onder de deur	6 mm	6 mm
Bovenpaneel	N.v.t.	N.v.t.
Vuurzijde	N.v.t.	N.v.t.
Aanslagsponning kozijn	Min. 17 mm	Min. 17 mm
Aanslagrubber kozijn	Indien van toepassing	Indien van toepassing
Uitvoering	Stomp	Stomp
Kantafwerking	ABS (2 mm)	ABS (2 mm)
Brandwerend	N.v.t.	N.v.t.
Rookwerend	N.v.t.	N.v.t.
Geluidwerend	N.v.t.	N.v.t.
In- en uitbraakwerend	N.v.t.	N.v.t.
Vochtwerend	Ja	Ja
Waterwerend	Ja	Ja
Klimaatklasse	N.v.t.	N.v.t.
GND	Optioneel GND label	Optioneel GND label
Glasopening	Optioneel	Optioneel
Hang- en sluitwerk	Optioneel	Optioneel
Kozijntype	Hout / Staal	Hout / Staal

-  Standaard
-  Brandwerend
-  Rookwerend Sa + S200
-  Rookwerend Sa
-  Rookwerend S200
-  Geluidwerend
-  In- en uitbraakwerend
-  Klimaatklasse
-  Klimaatklasse A
-  Klimaatklasse B
-  Klimaatklasse C
-  Watervast
-  Stralingswerend
-  Kogelwerend
-  Deurstel
-  Bovenpaneel
-  MVO / GND
-  Compleet element

