

Pico90 ClimateA

Brandwerende klimaatklasse utiliteitsdeur

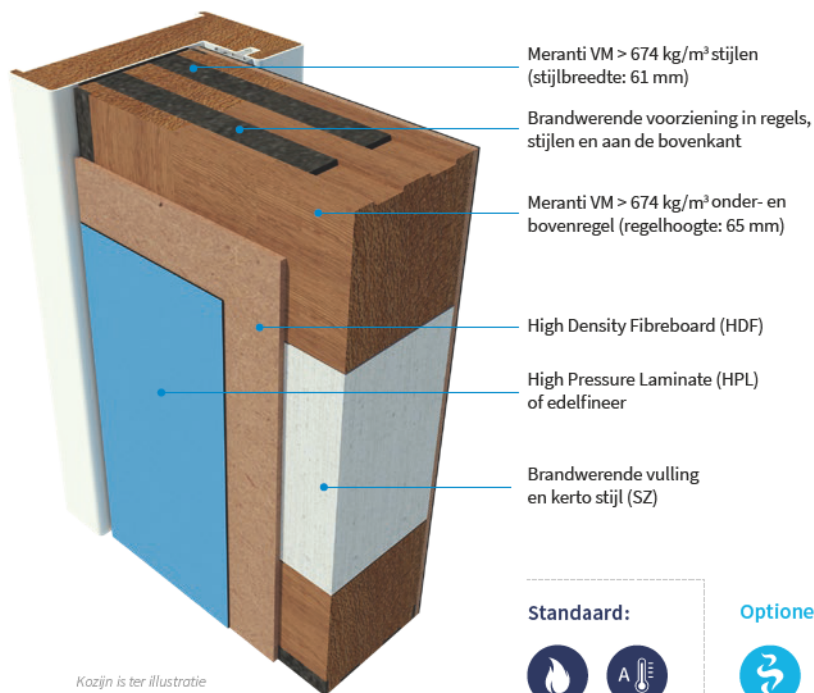

Kozijn is ter illustratie

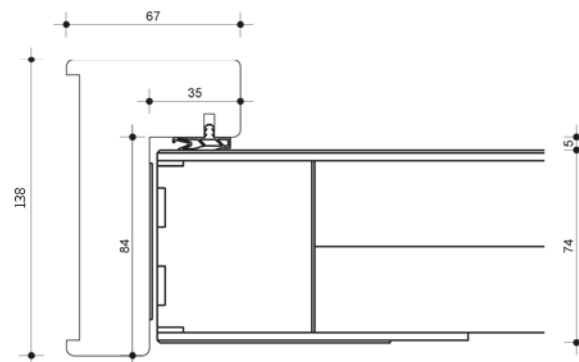

Standaard:













Optioneel:



Enkele deur

Deurbladdikte	HPL: 74 mm Machinaal geplamuurd: 74 mm
Gewicht	Ca. 28 kg/m ²
Maximale hoogte	2358 mm
Maximale breedte	1080 mm
Maximale oppervlak	2,55 m ²
Maximale ruimte onder de deur	6 mm
Bovenpaneel	N.v.t.
Vuurzijde	Draaiend naar het vuur toe en van het vuur af
Aanslagspanning kozijn	Houten kozijn: VM 800 kg/m ³ - 35 mm Stalen kozijn: 25 mm - gips/mortelgevuld
Aanslagrubber kozijn	Brandvertragende uitvoering
Uitvoering	Stomp
Kantafwerking	Onbehandeld, gelakt, geschilderd
Brandwerend	90 minuten; EW90
Rookwerend	Optioneel Sa
Geluidwerend	N.v.t.
In- en uitbraakwerend	Optioneel RC2
Klimaatklasse	A (23 grC-30% RV ↔ 18 grC-50% RV)
Krommingsklasse	2
MVO	Optioneel FSC®
GND	Optioneel GND label
Glasopening	N.v.t.
Hang- en sluitwerk	Optioneel
Kozijnstype	Hout / Staal

-  Standaard
-  Brandwerend
-  Rookwerend Sa + S200
-  Rookwerend Sa
-  Rookwerend S200
-  Geluidwerend
-  In- en uitbraakwerend
-  Klimaatklasse
-  Klimaatklasse A
-  Klimaatklasse B
-  Klimaatklasse C
-  Watervast
-  Stralingswerend
-  Kogelwerend
-  Deurstel
-  Bovenpaneel
-  MVO / GND
-  Compleet element

