

Pico60 Rw,p 43dB

Brand- en geluidswerende utiliteitsdeur (Rw 47dB)

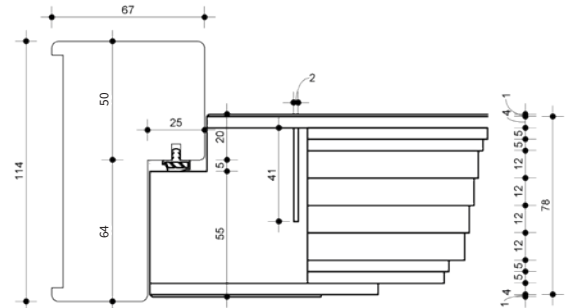

Standaard:

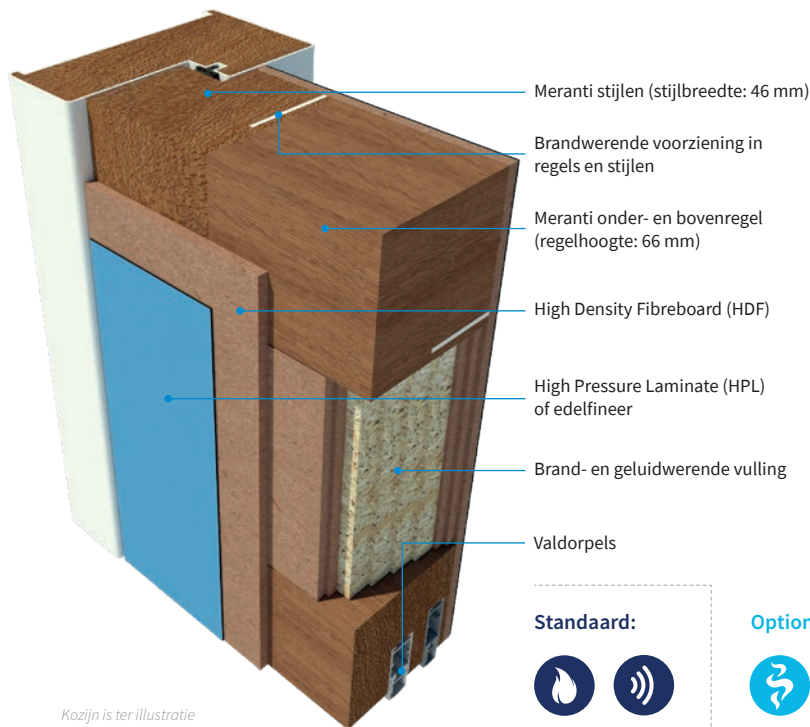













Optioneel:



Enkele deur

Deurbladdikte	HPL: 78 mm Machinaal geplamuurd: 78 mm
Gewicht	Ca. 42 kg/m ²
Maximale hoogte	2674 mm
Maximale breedte	1231 mm
Maximale oppervlak	2,99 m ²
Maximale ruimte onder de deur	6 mm
Bovenpaneel	N.v.t.
Vuurzijde	Draaiend naar het vuur toe en van het vuur af
Aanslagsponning kozijn	Houten kozijn: VM 550 kg/m ³ - 25 mm Stalen kozijn: 20 mm - gipsgevuld
Aanslagrubber kozijn	Brandvertragende uitvoering
Uitvoering	Indek
Kantafwerking	Onbehandeld, gelakt, geschilderd
Brandwerend	60 minuten; EW60
Brandvoortplanting	Optioneel brandklasse B, S1-d0
Rookwerend	Optioneel Sa / S200
Geluidwerend	Rw,p 43dB, Rw 47dB
In- en uitbraakwerend	Optioneel RC2
Klimaatklasse	Optioneel klimaat A / B / C
MVO	Optioneel FSC®
GND	Optioneel GND label
Glasopening	245x1245 mm, borstwing min. 350 mm
Hang- en sluitwerk	Optioneel
Kozijntype	Hout / Staal

-  Standaard
-  Brandwerend
-  Rookwerend Sa + S200
-  Rookwerend Sa
-  Rookwerend S200
-  Geluidwerend
-  In- en uitbraakwerend
-  Klimaatklasse
-  Klimaatklasse A
-  Klimaatklasse B
-  Klimaatklasse C
-  Watervast
-  Stralingswerend
-  Kogelwerend
-  Deurstel
-  Bovenpaneel
-  MVO / GND
-  Compleet element

